

For the best reception

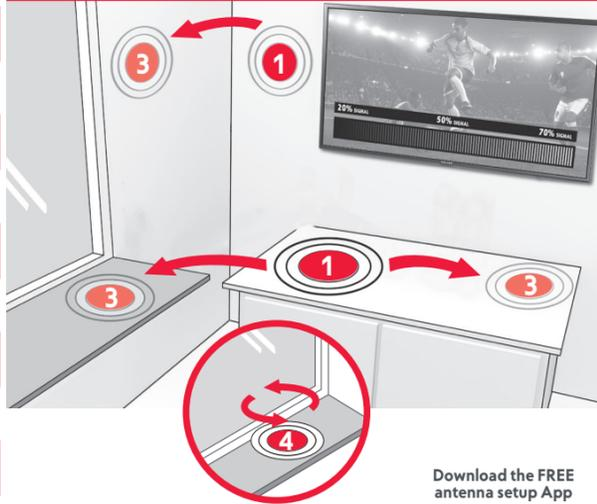

- 1 Point your antenna in the direction of the nearest transmitter for best reception and most channels possible.
- 2 For closest transmitter, check: www.ofa.com/antenna
- 3 For better signal strength and/or quality, try a different location, for example near a window
- 4 For better signal strength and/or quality, turn the antenna slightly
- 5 Learn how to set up your TV antenna movie: www.oneforall.com/support/antennas

Download the FREE antenna setup App



www.oneforall.com/assistantapp



- DE**
- 1 Richten Sie Ihre Antenne in Richtung des nächstgelegenen Senders, um den besten Empfang und die meisten Kanäle zu empfangen. Den nahegelegensten Sender finden Sie unter: www.ofa.com/antenna
 - 2 Um eine bessere Signalstärke und / oder -qualität zu erhalten, positionieren Sie die Antenne an verschiedenen Stellen, zum Beispiel in Fensternähe.
 - 3 Für eine bessere Signalstärke und / oder -qualität, können Sie die Antenne auch in verschiedene Richtungen drehen.
 - 4 Ein Video zum Aufstellen Ihrer Antenne finden Sie unter: www.oneforall.com/support/antennas
- FR**
- 1 Pointez votre antenne en direction de l'émetteur le plus proche pour avoir une meilleure réception et recevoir la plupart des chaînes possibles.
 - 2 Pour savoir la localisation de l'émetteur le plus proche, merci de vérifier le lien suivant: www.ofa.com/antenna
 - 3 Pour renforcer le signal et / ou avoir une meilleur qualité du signal, essayez un emplacement différent, par exemple près d'une fenêtre.
 - 4 Pour renforcer le signal et / ou avoir une meilleur qualité du signal, vous devrez peut-être tourner légèrement l'antenne.
 - 5 Apprenez comment configurer votre antenne TV via la vidéo dans le lien suivant: www.oneforall.com/support/antennas
- ES**
- 1 Dirija su antena en dirección del transmisor mas cercano para la mejor recepción y así captar la mayor parte de canales posibles.
 - 2 Para verificar donde esta el transmisor mas cercano por favor vea: www.ofa.com/antenna
 - 3 Para mejorar la intensidad de la señal y/o calidad, pruebe en una ubicación diferente, por ejemplo cerca de una ventana.
 - 4 Para mejorar la intensidad de la señal y/o calidad, es posible que tenga que girar la antena ligeramente.
 - 5 Aprenda a configurar su antena TV movie: www.oneforall.com/support/antennas
- IT**
- 1 Puntare l'antenna nella direzione del trasmettitore piu' vicino per una migliore ricezione e piu' canali possibili.
 - 2 Per i trasmettitori vicini si prega di controllare: www.ofa.com/antenna
 - 3 Per una migliore potenza di segnale e/o qualita' si provi un luogo differente, per esempio vicino ad una finestra.
 - 4 Per una migliore potenza di segnale e/o qualita' potrebbe essere necessario ruotare leggermente l'antenna.
 - 5 Filmato Scopri Come Impostare La Tua Antenna TV: www.oneforall.com/support/antennas

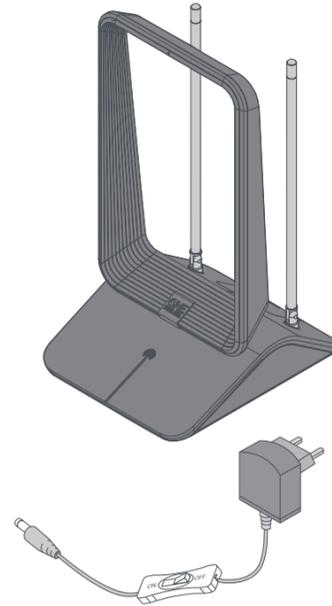

Power adapter UK
Model: H512001008
Input voltage: 100-240 V
Input AC frequency: 50/60 Hz
Output voltage: 12.0 VDC
Output current: 0.1 A
Output power: 1.2 W
Average active efficiency: 74.6 %
No-load power consumption: 0.07 W

Class II equipment. Adapter enclosure is double insulated. Risk of electric shock, do NOT open!

Power adapter EU
Model: H51200100V
Input voltage: 100-240 V
Input AC frequency: 50/60 Hz
Output voltage: 12.0 VDC
Output current: 0.1 A
Output power: 1.2 W
Average active efficiency: 74.6 %
No-load power consumption: 0.07 W

Class II equipment. Adapter enclosure is double insulated. Risk of electric shock, do NOT open!

GB: To completely remove power from the antenna, disconnect the power adaptor from the power socket.

DE: Um die Antenne vollständig von der Stromversorgung zu trennen, entfernen Sie das Netzteil aus der Steckdose.

FR: Pour couper complètement l'alimentation de votre antenne, veuillez débrancher le câble alimenté secteur de la prise d'alimentation.

IT: Per rimuovere completamente l'alimentazione dall'antenna, scollegare l'alimentatore dalla presa di corrente.

ES: Para extraer completamente la alimentación de la antena, desconecte el cable de alimentación de la toma de corriente.

1 START

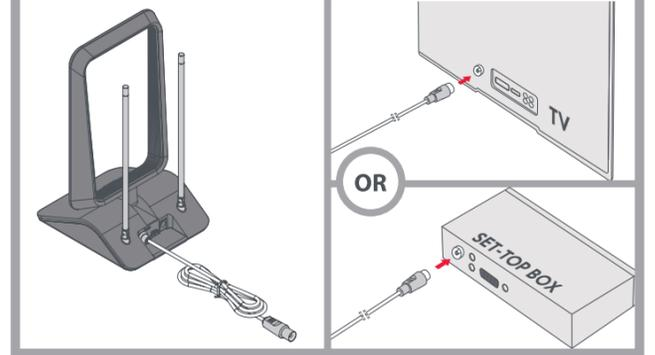

2

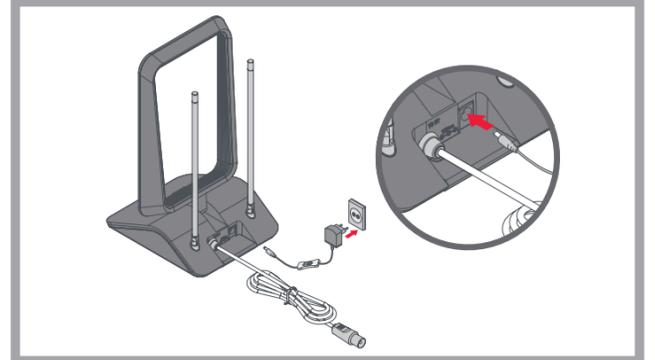

3 POSITION THE ANTENNA:

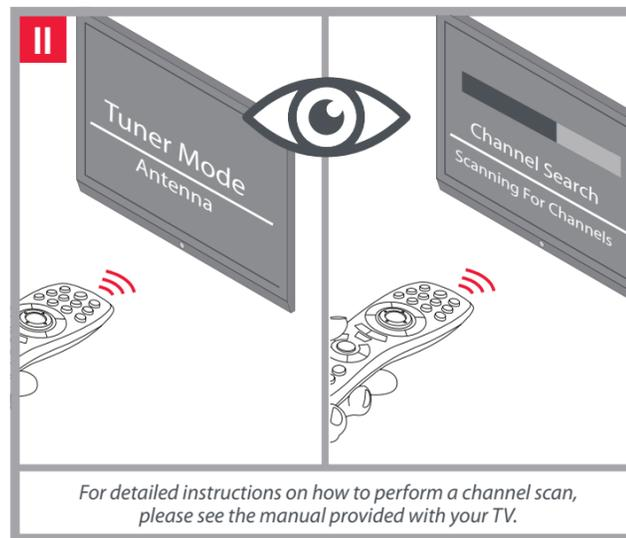
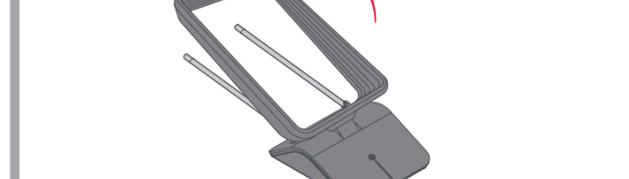
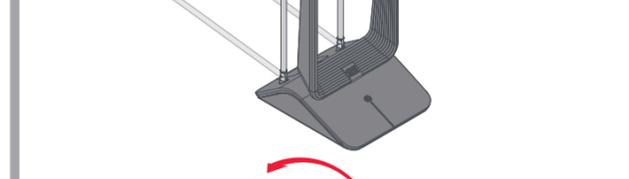
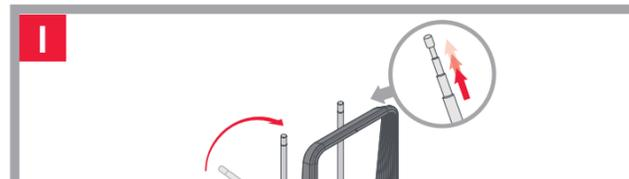

For detailed instructions on how to perform a channel scan, please see the manual provided with your TV.

FINISH

WWW.ONEFORALL.COM/TIPS-AND-TRICKS

Connect with us



facebook.com/oneforallworldwide



[@oneforall.worldwide](https://www.instagram.com/oneforall.worldwide)



linkedin.com/company/one-for-all-worldwide/



youtube.com/users/oneforallproducts

TURN THE ANTENNA SLIGHTLY FOR BETTER SIGNAL STRENGTH OR RECEPTION QUALITY - www.oneforall.com/support/antennas

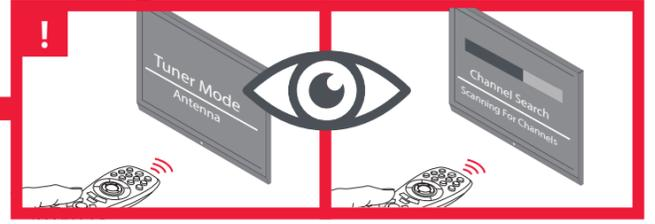
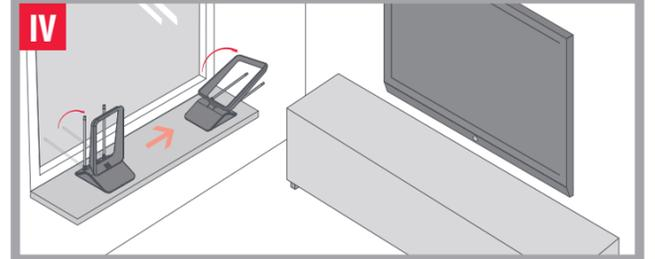
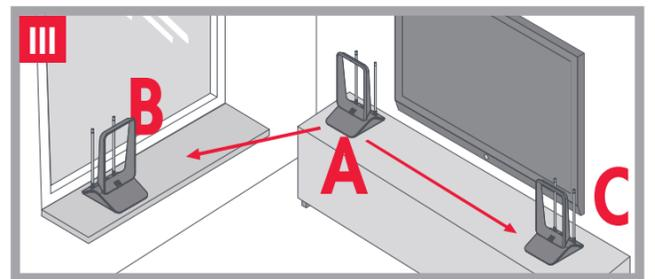

UK Hereby, Universal Electronics BV declares that the radio equipment type SV9460/65 is in compliance with Directive 2014/53/EU. The full text of the EU declaration of conformity is available at the following internet address: http://www.oneforall.com/doc_sv9460_65

DE Hiermit erklärt Universal Electronics BV, dass der Funkanlagentyp SV9460/65 der Richtlinie 2014/53/EU entspricht. Der vollständige Text der EU-Konformitätserklärung ist unter der folgenden Internetadresse verfügbar: http://www.oneforall.com/doc_sv9460_65

FR Le soussigné, Universal Electronics BV, déclare que l'équipement radioélectrique de type SV9460/65 est conforme à la directive 2014/53/UE. Le texte complet de la déclaration UE de conformité est disponible à l'adresse internet suivante: http://www.oneforall.com/doc_sv9460_65

ES Por la presente, Universal Electronics BV declara que el tipo de equipo radioeléctrico SV9460/65 es conforme con la Directiva 2014/53/UE. El texto completo de la declaración UE de conformidad está disponible en la dirección internet siguiente: http://www.oneforall.com/doc_sv9460_65

PT O(a) abaixo assinado(a) Universal Electronics BV declara que o presente tipo de equipamento de rádio SV9460/65 está em conformidade com a Diretiva 2014/53/UE. O texto integral da declaração de conformidade está disponível no seguinte endereço de Internet: http://www.oneforall.com/doc_sv9460_65

IT Il fabbricante, Universal Electronics BV, dichiara che il tipo di apparecchiatura radio SV9460/65 è conforme alla direttiva 2014/53/UE. Il testo completo della dichiarazione di conformità UE è disponibile al seguente indirizzo Internet: http://www.oneforall.com/doc_sv9460_65

NL Hierbij verklaar ik, Universal Electronics BV, dat het type radioapparatuur SV9460/65 conform is met Richtlijn 2014/53/UE. De volledige tekst van de EU-conformiteitsverklaring kan worden geraadpleegd op het volgende internetadres: http://www.oneforall.com/doc_sv9460_65

DK Hermed erklærer Universal Electronics BV, at radioudrustningen SV9460/65 er i overensstemmelse med direktiv 2014/53/UE. EU-overensstemmelseserklæringens fulde tekst kan findes på følgende internetadresse: http://www.oneforall.com/doc_sv9460_65

NO Hermed erklærer Universal Electronics BV, at radioudrustningen SV9460/65 er i samsvar med direktiv 2014/53/UE. Den fulle teksten til EU-samsvarserklæringen er tilgjengelig på følgende internetadresse: http://www.oneforall.com/doc_sv9460_65

SE Härmed försäkrar Universal Electronics BV att denna typ av radioutrustning SV9460/65 överensstämmer med direktiv 2014/53/UE. Den fullständiga texten till EU-försäkringen om överensstämmelse finns på följande webbadress: http://www.oneforall.com/doc_sv9460_65

FI Universal Electronics BV vakuuttaa, että radiolaitetyypin SV9460/65 on direktiivin 2014/53/EU mukainen. EU vaatimusten mukaisuusvakuutuksen täysimittainen teksti on saatavilla seuraavassa internetosoitteessa: http://www.oneforall.com/doc_sv9460_65

GR Με την παρούσα ο/η Universal Electronics BV, δηλώνει ότι ο ραδιοεξοπλισμός SV9460/65 πληροί την οδηγία 2014/53/ΕΕ. Το πλήρες κείμενο της δήλωσης συμμόρφωσης ΕΕ διατίθεται στην ακόλουθη ιστοσελίδα στο διαδίκτυο: http://www.oneforall.com/doc_sv9460_65

TK Burada Universal Electronics BV, SV9460/65 adlı radio cihazının 2014/53/EU direktifine uygun olduğunu beyan etmektedir. İlgili Avrupa birliği deklarasyonunun tam metnine şu adresten ulaşılabilir: http://www.oneforall.com/doc_sv9460_65

PO Universal Electronics BV niniejszym oświadczam, że typ urządzenia radiowego SV9460/65 jest zgodny z dyrektywą 2014/53/UE. Pełny tekst deklaracji zgodności UE jest dostępny pod następującym adresem internetowym: http://www.oneforall.com/doc_sv9460_65

CZ Tímto Universal Electronics BV prohlašuje, že typ rádiového zařízení SV9460/65 je v souladu se směrnicí 2014/53/EU. Úplné znění EU prohlášení o shodě je k dispozici na této internetové adrese: http://www.oneforall.com/doc_sv9460_65

HU Universal Electronics BV igazolja, hogy a SV9460/65 típusú rádióberendezés megfelel a 2014/53/EU irányelvnek. Az EU-megfelelőségi nyilatkozat teljes szövege elérhető a következők internetes címen: http://www.oneforall.com/doc_sv9460_65

BG С настоящото Universal Electronics BV декларира, че този тип радиосъоръжение SV9460/65 е в съответствие с Директива 2014/53/ЕС. Цялостният текст на ЕС декларацията за съответствие може да се намери на следния интернет адрес: http://www.oneforall.com/doc_sv9460_65

RO Prin prezenta, Universal Electronics BV declară că tipul de echipamente radio SV9460/65 este în conformitate cu Directiva 2014/53/UE. Textul integral al declarației UE de conformitate este disponibil la următoarea adresă internet http://www.oneforall.com/doc_sv9460_65

SK Universal Electronics BV týmto vyhlasuje, že rádiové zariadenie typu SV9460/65 je v súlade so smernicou 2014/53/EU. Úplné EU vyhlásenie o zhode je k dispozícii na tejto internetovej adrese: http://www.oneforall.com/doc_sv9460_65

CR Universal Electronics BV ovime izjavljuje da je radijska oprema tipa SV9460/65 u skladu s Direktivom 2014/53/UE. Cjeloviti tekst EU izjave o sukladnosti dostupan je na sljedećoj internetskoj adresi: http://www.oneforall.com/doc_sv9460_65